

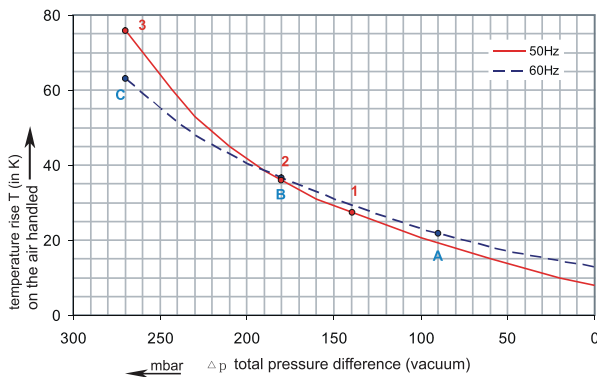

1RSCB 45-65

Performance curve for Vacuum pump

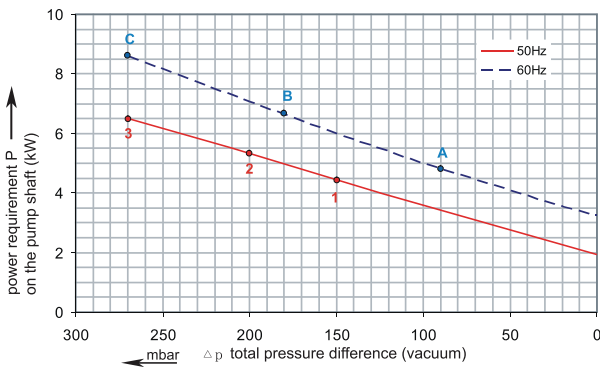
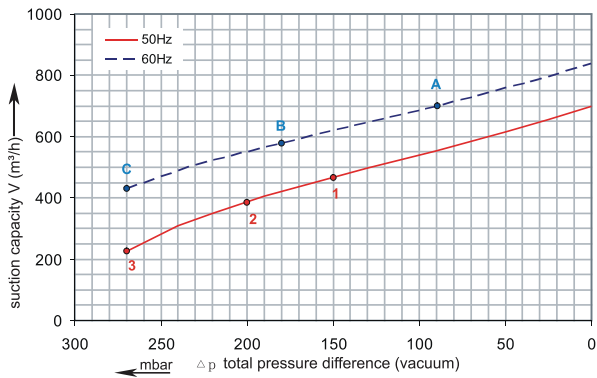

1RSCB 45-65

Performance curve for Compressor

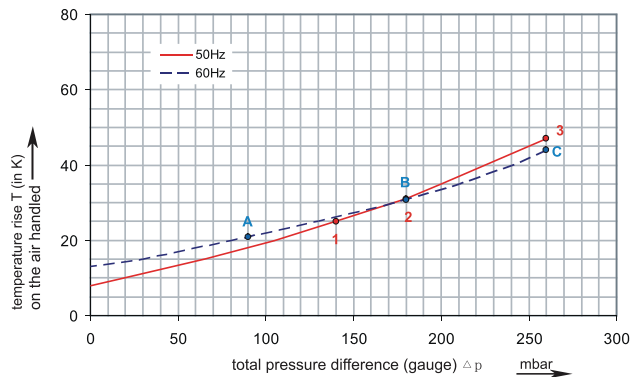
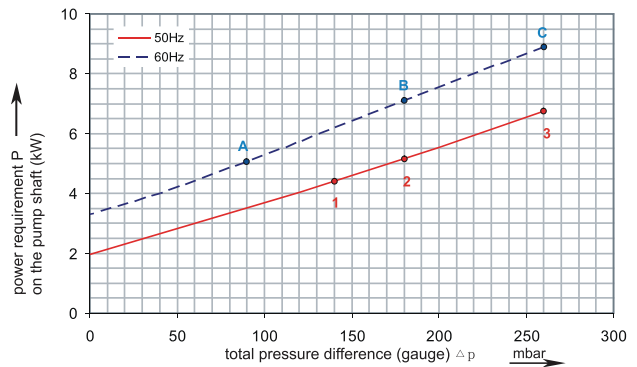
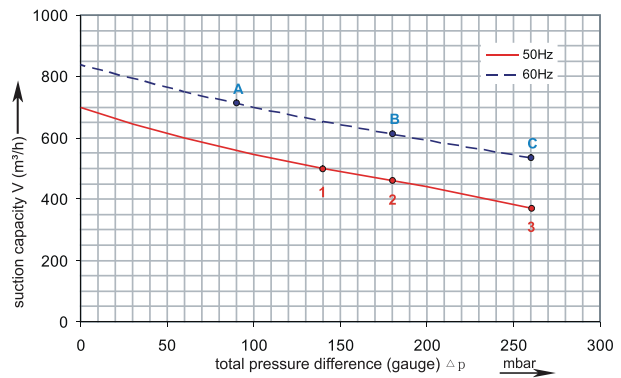

The performance curves are based on air at a temperature of 15 °C and an atmospheric pressure of 1013 mbar with a tolerance of +/- 10 %. The total pressure differences are valid for suction and ambient temperatures up to 25 °C. For other conditions please confer with us.

Each RSC type can be applied both as vacuum pump and compressor in continuous operation over the total stated performance curve range. The motors are available as standard for the input voltage range of 50 and 60 Hz and for protection category IP 55



Madan Technologies
Maagan Michael
D. N. Menashe
3780500 Israel

Tel: +972-4-6243353
Fax: +972-4-6243366
sales@madantec.com
www.madantec.com

RENOVA

1RSCB 45-65

Curve No.	Model	Freq. (Hz)	Rated power (KW)	Voltage (V)	Current (A)	Sound Level [dB(A)]	Weight (Kg)
1	1RSCB45-65 4.0T	50	4.0	345-415 Δ / 600-720Y	9.5 Δ / 5.5Y	70	57
A	1RSCB45-65 4.0T	60	4.6	380-480 Δ / 660-720Y	9.5 Δ / 5.5Y	74	57
2	1RSCB45-65 5.5T	50	5.5	345-415 Δ / 600-720Y	12.9 Δ / 7.4Y	70	66
B	1RSCB45-65 5.5T	60	6.3	380-480 Δ / 660-720Y	12.9 Δ / 7.4Y	74	66
3	1RSCB45-65 7.5T	50	7.5	345-415 Δ / 600-720Y	16.7 Δ / 9.6Y	70	69
C	1RSCB45-65 7.5T	60	8.6	380-480 Δ / 660-720Y	17.3 Δ / 10.0Y	74	69

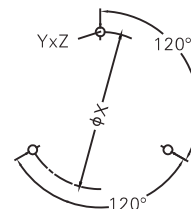
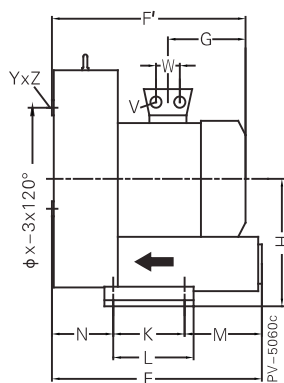
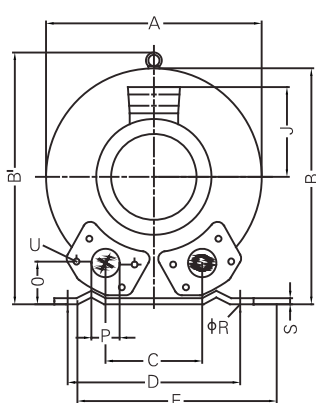

Model	A	B	C	D	E	F	G	H	J	K	L	M	N	O	ØP
1RSCB45-65 4.0T	451	461	152	356	449	449	230	240	148	170	217	140	139	65	2½"
1RSCB45-65 5.5T	451	461	152	356	449	449	247	240	167	170	217	140	139	65	2½"
1RSCB45-65 7.5T	451	461	152	356	449	449	247	240	167	170	217	140	139	65	2½"

Model	ØR	S	V	ØX	YxZ	X-Holes
1RSCB45-65 4.0T	15	6	4xM32x1.5	286	M12x20	0°/120°/240°
1RSCB45-65 5.5T	15	6	4xM32x1.5	286	M12x20	0°/120°/240°
1RSCB45-65 7.5T	15	6	4xM32x1.5	286	M12x20	0°/120°/240°